

Candy

Typ T2 BOSS

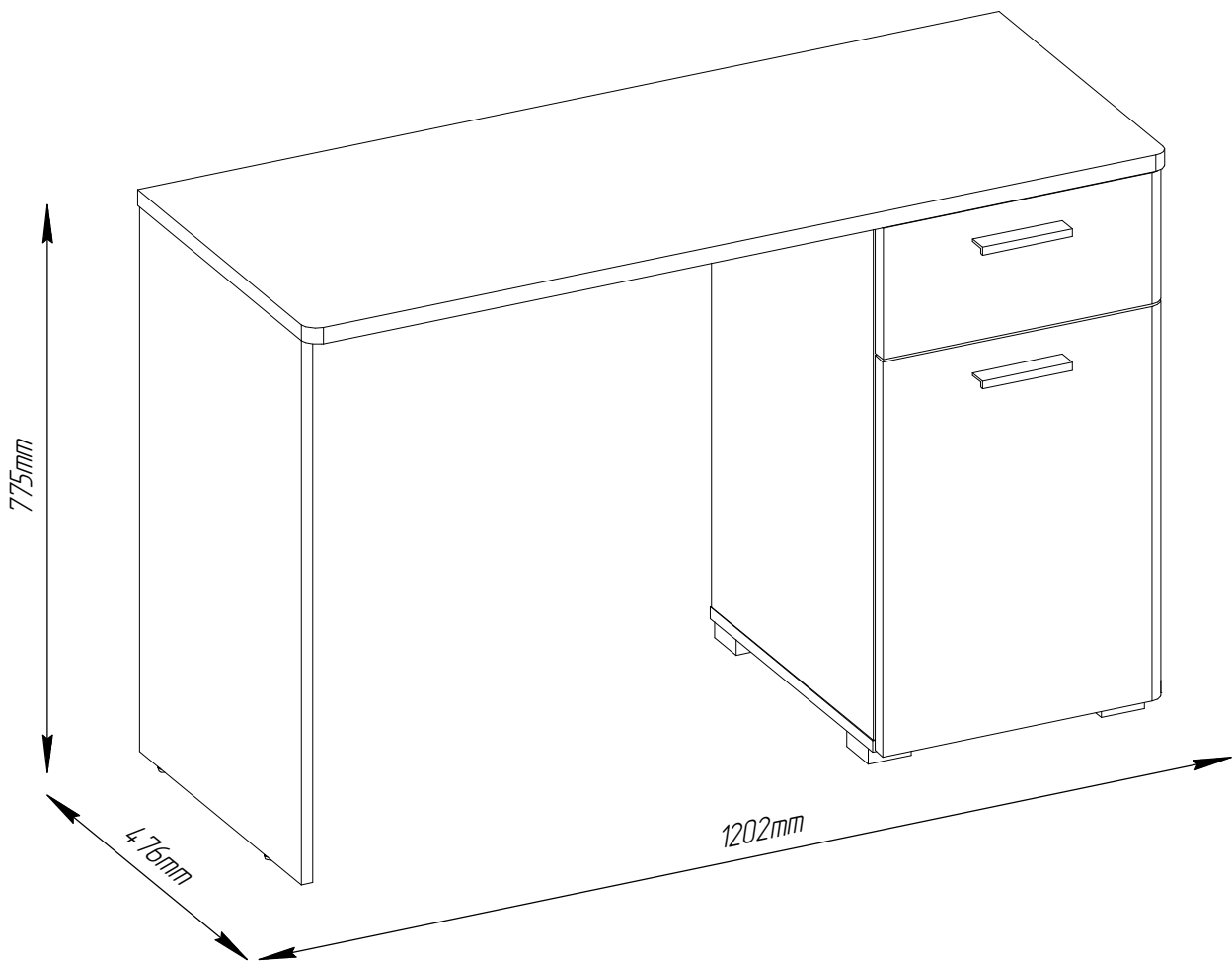

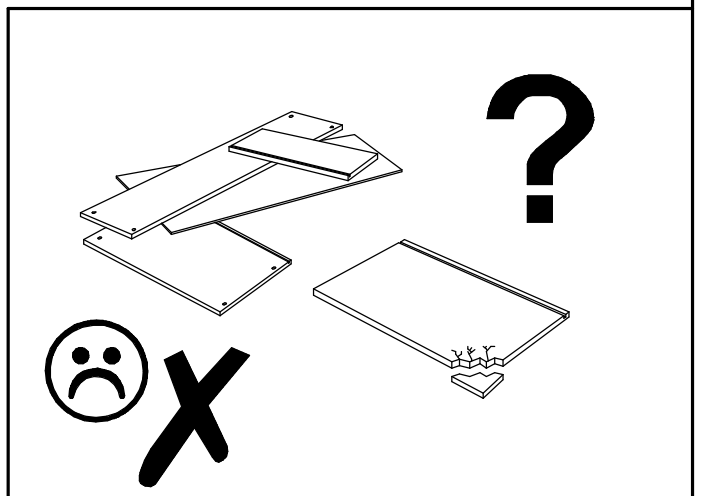

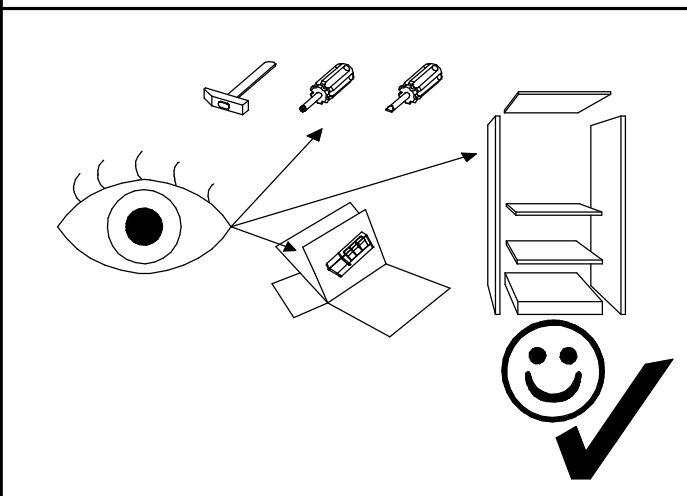
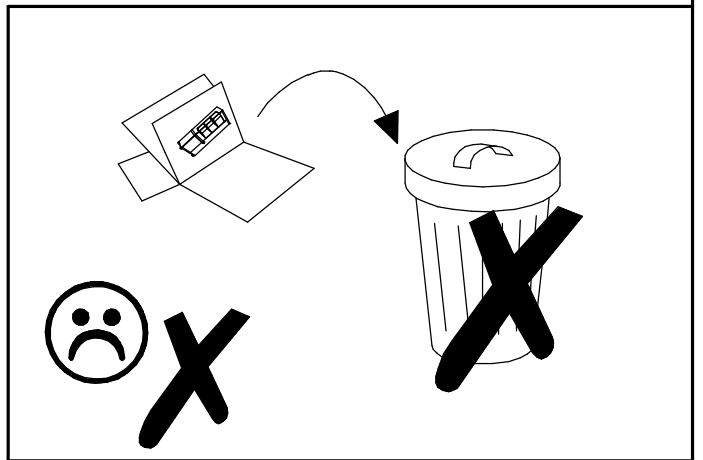
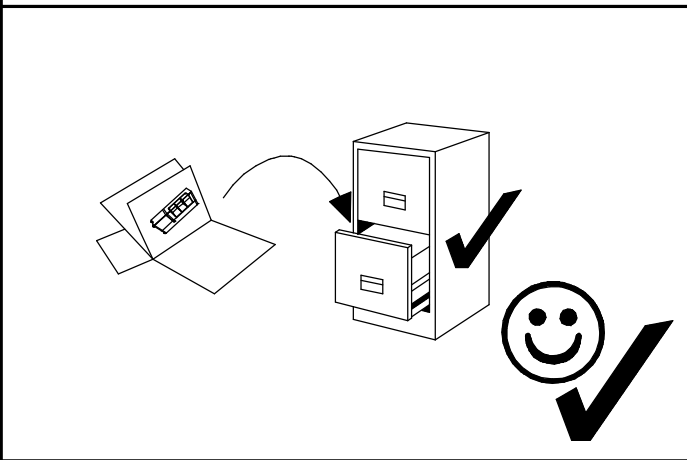
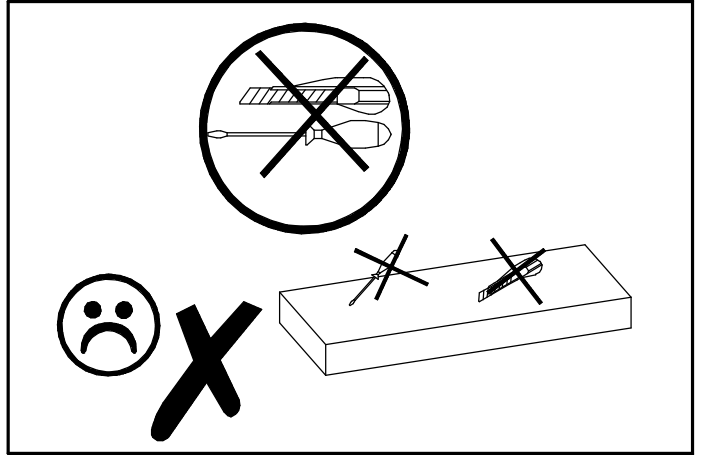
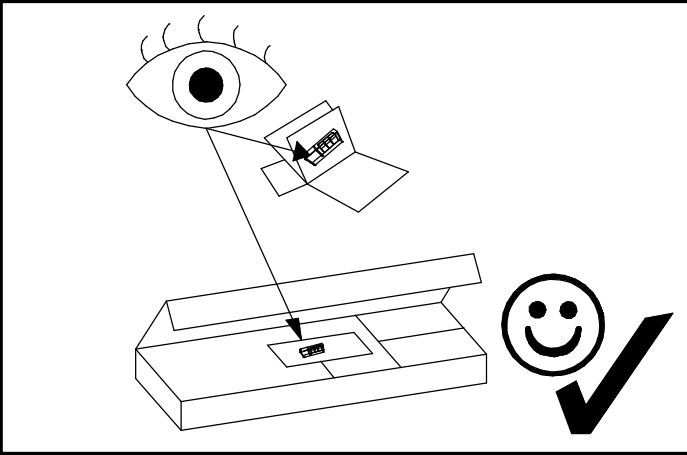
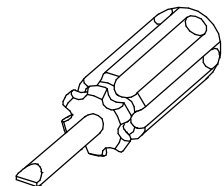
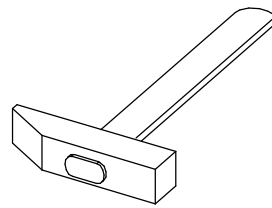
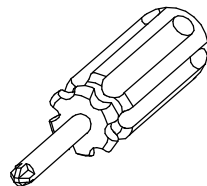
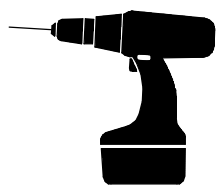
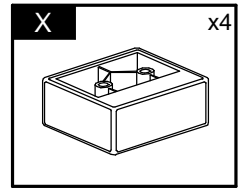
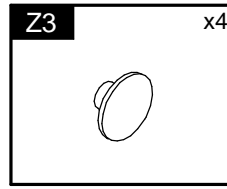
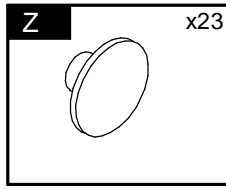
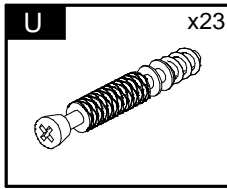
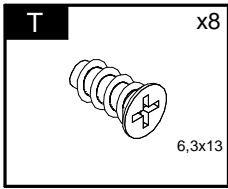
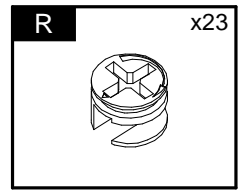
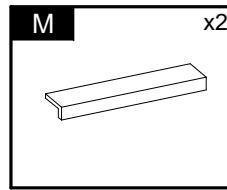
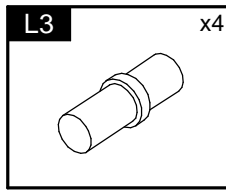
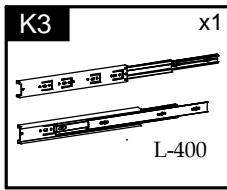
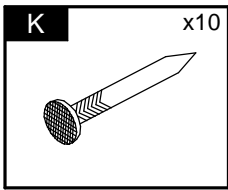
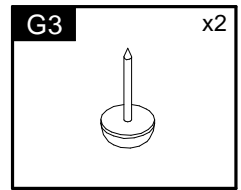
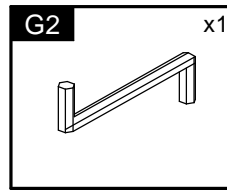
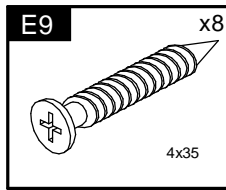
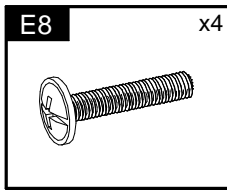
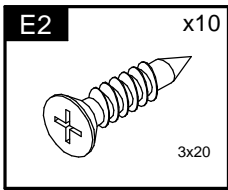
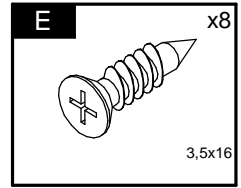
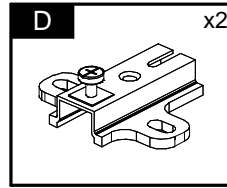
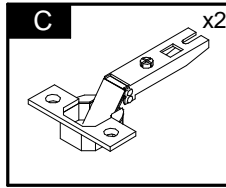
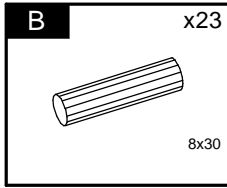
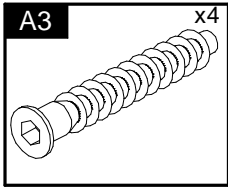
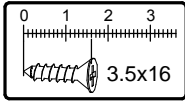
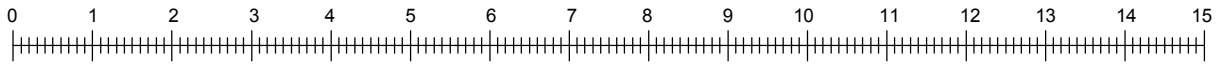

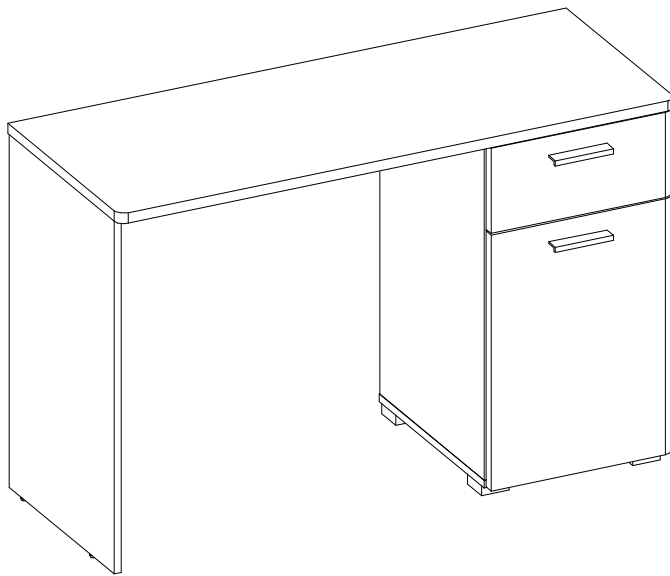

| Element symbol | Measurements | | | | Code | Paket |
|----------------|--------------|------|-----|---|-----------|-------|
| 1 | 1202 | 476 | 22 | 1 | 1003/2003 | 1/2 |
| 2 | 748 | 450 | 16 | 1 | 1027 | 1/2 |
| 3 | 782 | 190 | 16 | 1 | 1028 | 2/2 |
| 4 | 402 | 452 | 16 | 1 | 1029/2029 | 1/2 |
| 5 | 712 | 450 | 16 | 1 | 1030/2030 | 1/2 |
| 6 | 712 | 450 | 16 | 1 | 1031 | 1/2 |
| 7 | 712 | 368 | 16 | 1 | 1032 | 1/2 |
| 8 | 368 | 423 | 16 | 1 | N/A | 1/2 |
| 9 | 400 | 120 | 16 | 1 | 1035/2035 | 1/2 |
| 10 | 310.5 | 99.5 | 16 | 1 | 1024 | 1/2 |
| 11 | 400 | 120 | 16 | 1 | 1023/2034 | 1/2 |
| 12 | 320 | 402 | 3.5 | 1 | N/A | 2/2 |
| 13 | 543 | 397 | 22 | 1 | 1059/3034 | 2/2 |
| 14 | 397 | 182 | 22 | 1 | 1060/3026 | 2/2 |

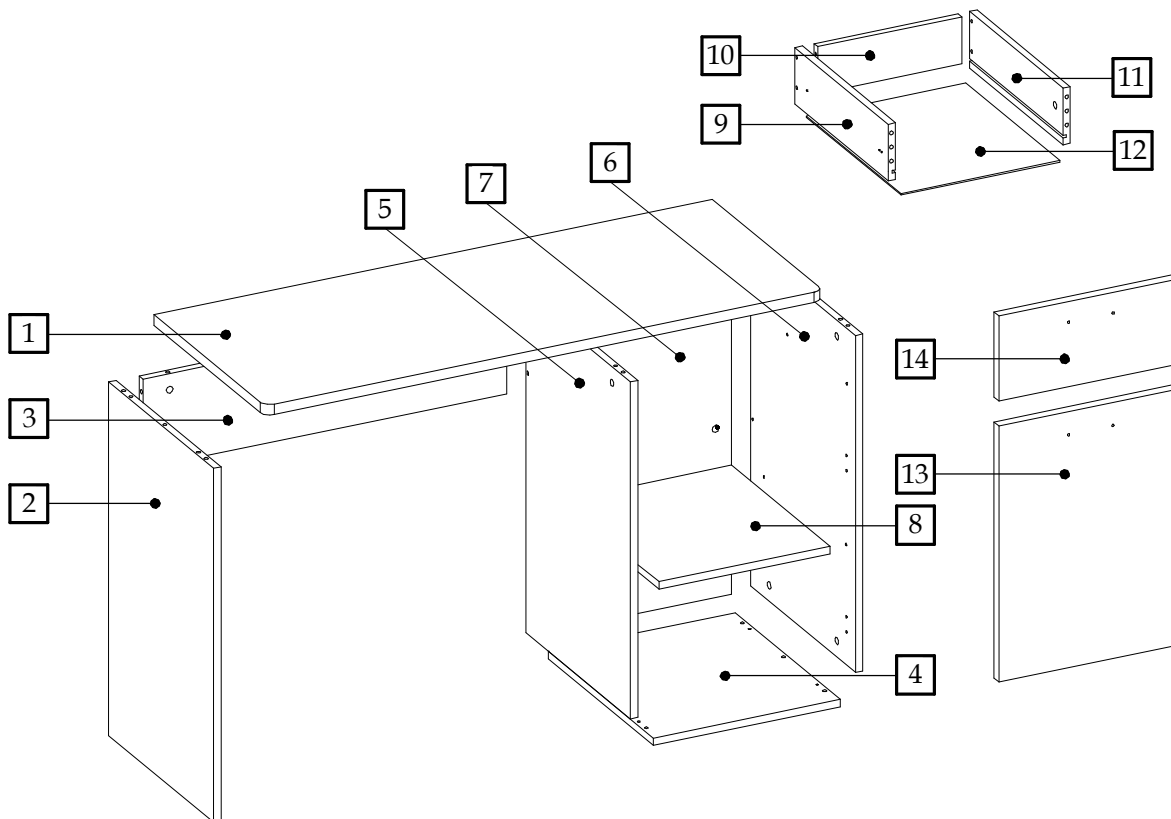

2

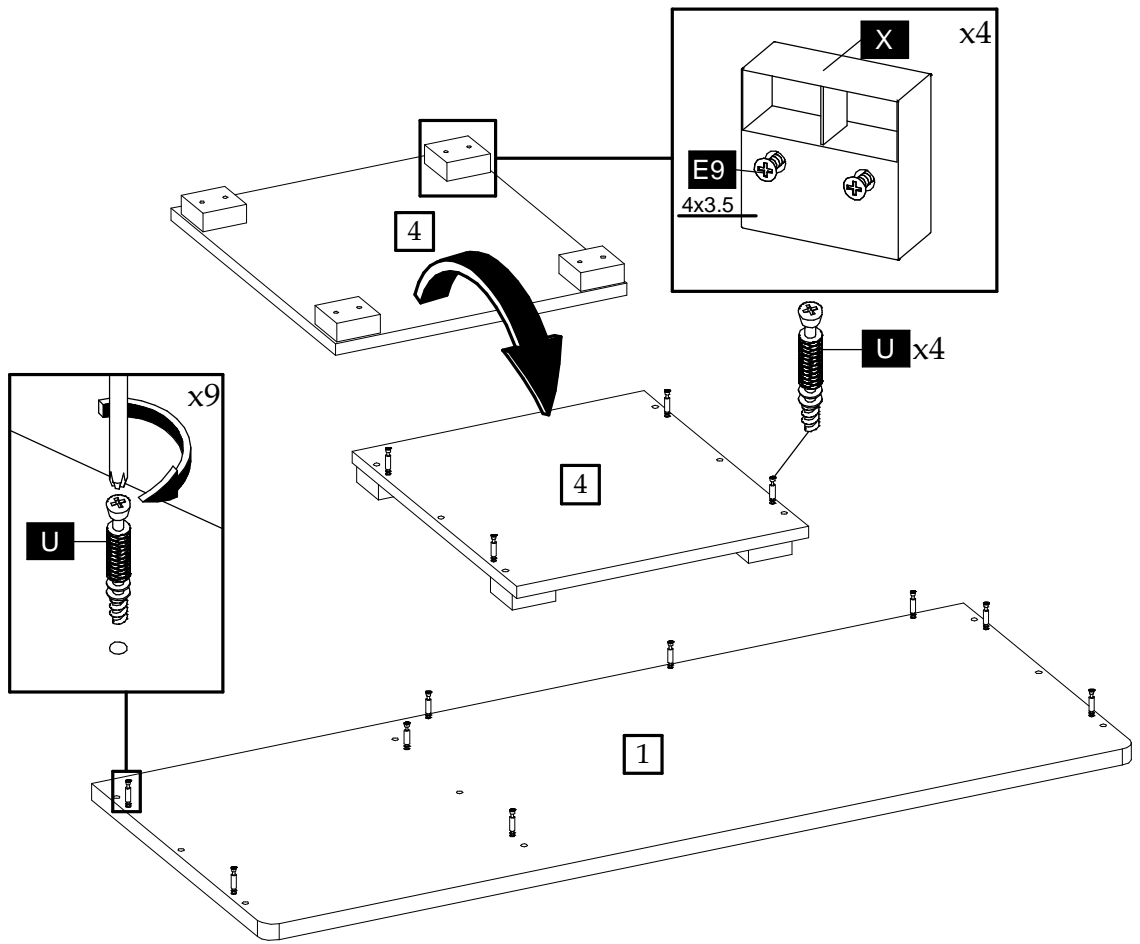

3

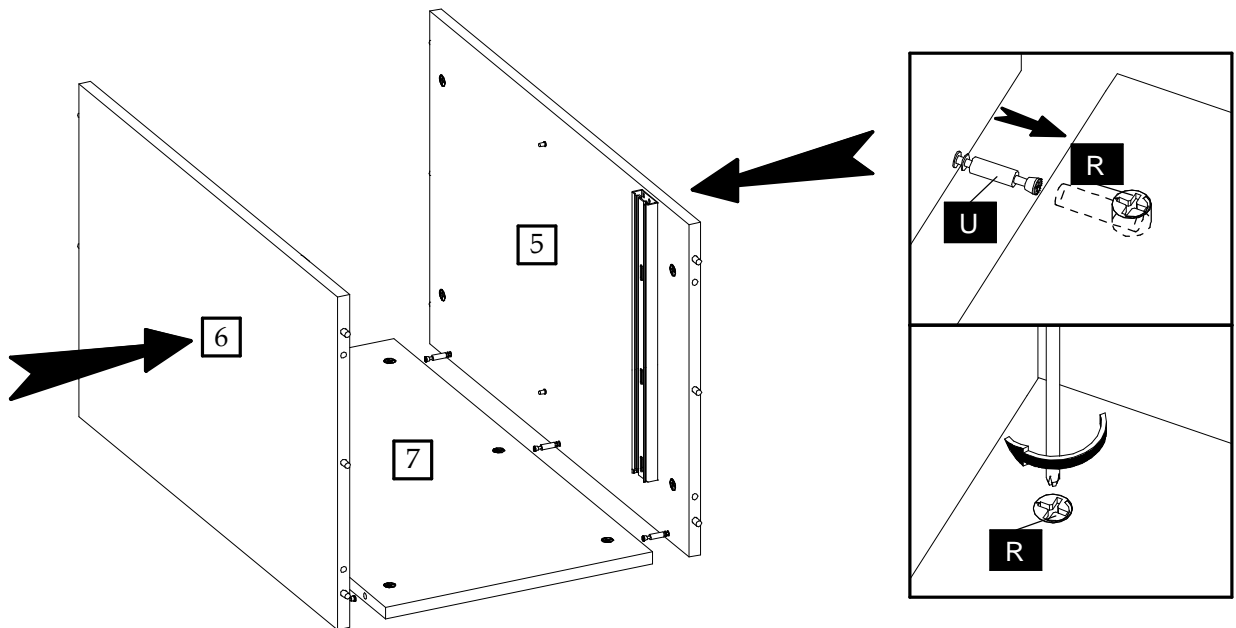

4

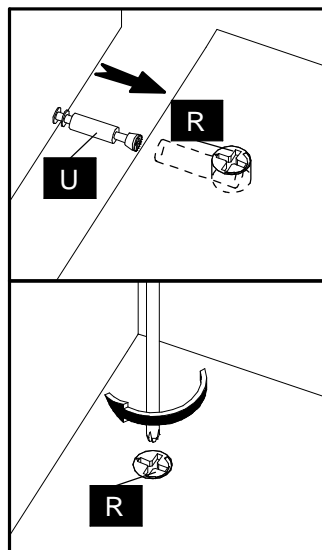
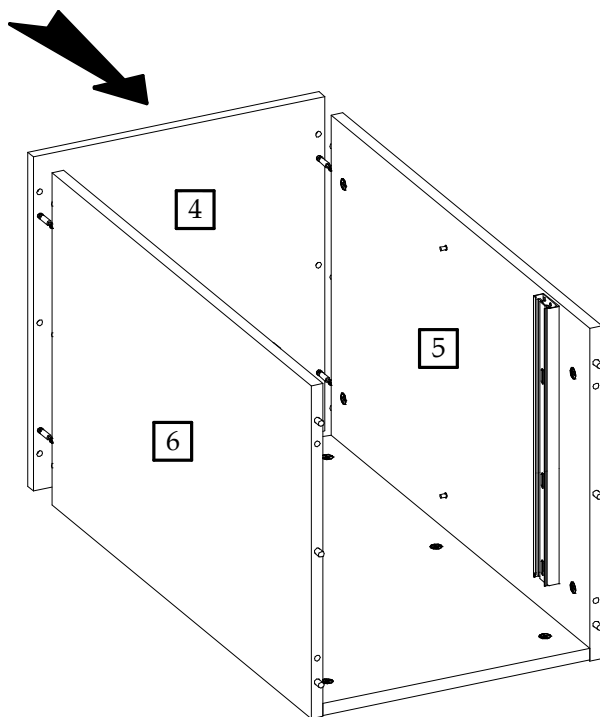

5

